



**Model PA-S450**

**400 Watt 4-Channel Amplifier**

**Owner's  
Manual**

## INDEX

Specifications .....	1
Precautions .....	2
Installation Instructions .....	3
Wiring Instructions .....	4 - 5
4-Channel and Mixed-Mono Input Wiring Diagram .....	6
4-Channel and Mixed-Mono Output Wiring Diagram .....	7
3-Channel Input Wiring Diagram .....	8
3-Channel Output Wiring Diagram .....	9
2-Channel Mono (Bridged) Input Wiring Diagram .....	10
2-Channel Mono (Bridged) Output Wiring Diagram .....	11
Operation .....	12 - 13
Warranty .....	Back Cover

## HIGH PERFORMANCE STEREO AMPLIFIER

This power amplifier has been designed to provide high quality performance with a minimum of maintenance. However, its performance will only be as good as the care and quality of components with which it is installed. We therefore advise that you read these instructions very carefully to familiarize yourself with the product and its features.

Should you require assistance with the installation or wiring of this unit, please call our toll-free "HELP" line at 1-800-645-4994 during the days/hours shown.

**HELP!**  
**1-800-645-4994**  
Monday-Friday 8:30am-7:00pm Eastern  
Saturday 9:00am-5:00pm Eastern

## SPECIFICATIONS

Maximum Output Power:		Input Impedance:	low-level 10K ohms
4-Channel Operation:	100 watts x 4		high-level 100 ohms
2-Channel Operation:	200 watts x 2	Input Sensitivity:	low-level 200 mv. - 4 v.
Output Power @ 0.05% T.H.D.:			high-level 2 - 10 v.
4-Channel Operation:	50 watts RMS x 4	Filter Types:	low-pass and hi-pass
2-Channel Operation:	125 watts RMS x 2	Filter Slope:	18 dB/octave
Output Impedance:	2 - 8 ohms (stereo)	Filter Crossover:	50 - 180 Hz. (selectable)
	4 - 8 ohms (mono)	Bass Boost:	+8 dB @ 45 Hz.
Frequency Response:	10 - 50,000 Hz. $\pm$ 1 dB	Supply Voltage:	12 volts, negative ground
Channel Separation:	50 dB	Fuse Rating:	20 amps. x 2
Signal / Noise Ratio:	90dB (A-Weighted)	Dimensions (W x H x D):	10-3/4" x 2-3/8" x 11-1/2" 273 mm x 62 mm x 290 mm

\* Due to continuing improvement, Audiovox reserves the right to change features and design without notice.

## PRECAUTIONS

1. Although this unit is designed with built-in self-protection circuits, there may be a possibility of damage if it is not wired correctly. Please follow the wiring instructions carefully for the type of system being used.
2. The last lead to be connected is the wire to the positive (+) terminal of the battery. Connect this wire only after having completed and checked all other connections to the amplifier.
3. By nature of its design, a power amplifier generates heat and requires good air circulation around it to dissipate that heat. Do not install the amplifier in an enclosed area which does not permit adequate air circulation. Should the temperature of the unit rise too high, the internal thermal sensors will shut off operation until it has cooled down sufficiently.
4. If fuse replacement is necessary, use only fuses of the same ampere rating as originally supplied with the unit. The use of fuses with incorrect ratings may cause serious damage to the amplifier. If fuses blow consistently, carefully check all electrical connections to the unit.
5. Supply of adequate battery voltage is critical to the proper operation of the power amplifier. The leads to the battery and chassis ground **must** be of a thick enough gauge to provide this voltage to the amplifier. We recommend #10 gauge wire or larger (smaller gauge #) for the battery and ground leads.
6. Make certain that the speaker(s) to be used with this amplifier are capable of handling the output power (wattage) of the unit. Use of speaker(s) not rated for the output of this amplifier may cause damage to or failure of the speaker(s) for which Audiovox will not be liable.

## INSTALLATION INSTRUCTIONS

1. Select a mounting area where the amplifier will have sufficient air circulation for proper cooling. Inadequate air circulation will cause the temperature of the amplifier to rise and will trigger the thermal protection mode.
2. Place the amplifier on the mounting surface and mark the locations of the four mounting holes as shown in the illustration.
3. Remove the amplifier and drill a 1/8" hole at each of the four locations.

**CAUTION:** Before drilling the holes, look at the underside of the mounting surface. Always check carefully to avoid drilling into wiring, braces, fuel or brake lines. **CHECK BEFORE YOU DRILL !**

4. Apply a self-adhesive rubber washer to the bottom of the amplifier at each of the 4 screw locations. Secure the amplifier to the mounting surface using the self-tapping screws provided.
5. Attach the plastic end panels to the amplifier by removing the protective paper from the self-adhesive strips on the bottom of the panels and pressing them into position on the amplifier.

## INSTALLATION DIAGRAM

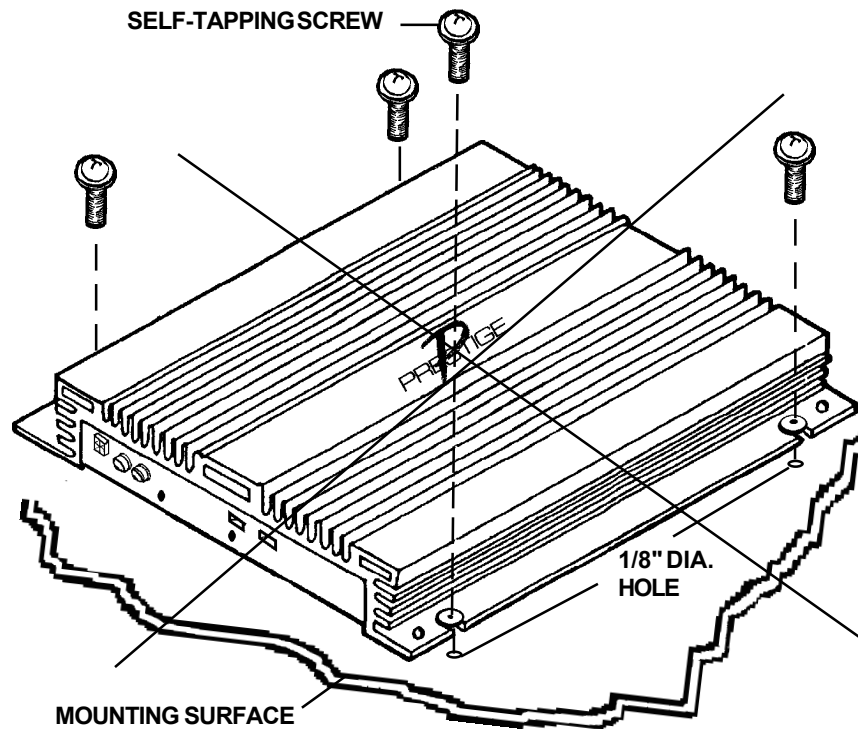

## WIRING INSTRUCTIONS

The wiring of your amplifier will depend on the system and speakers you are using but will either be a 4-channel, 3-channel, 2-channel, or mixed-mono application. The following pages illustrate the input and output wiring for these types. Please refer to the appropriate diagrams for the system configuration you are using.

The power and speaker wire connections for this amplifier are made via screw tightened terminal blocks. Loosen the screw for the connection to be made and fully insert the wire (strip 1/2" of insulation from the end) under the respective screw on the side panel (crimp-on "U" terminals are provided to simplify wiring and we recommend their use). Tighten the screw down to secure the wire.

### 1. Power Connection

The battery terminal (+12V) must be connected directly to the positive terminal of the vehicle battery to provide an adequate voltage source and minimize noise. Connecting the battery terminal lead to any other point (such as the fuse block) will reduce the power output and may cause noise and distortion. Use only **#10** gauge or thicker (smaller gauge #) wire for this lead and connect it to the terminal of the battery after all other wiring is completed.

### 2. Ground Connection

The ground terminal (GND) connection is also critical to the correct operation of the amplifier. Use a wire of the same gauge as the power connection (**#10** or thicker) and connect it between the ground terminal (GND) of the amplifier and a metal part of the vehicle close to the mounting location. This wire should be as short as possible and any paint or rust at the grounding point should be scraped away to provide a clean metal surface to which the end of the ground wire can be screwed or bolted.

### 3. Remote Turn-On Connection

The amplifier is turned on by applying +12 volts to the remote turn-on terminal (REM). The wire lead to this terminal should be connected to the "Auto-Antenna" lead from the car stereo which will provide the +12 volts only when the car stereo is turned on. If the car stereo does not provide an Auto-Antenna lead, the remote turn-on lead may be wired to an "Accessory" or "Radio" terminal in the car's fuse block. This will turn the amplifier on and off with the ignition key, regardless of whether the car stereo is on or off. The remote turn-on lead does not carry large currents, so #20 gauge wire may be used for this application.

## WIRING INSTRUCTIONS

### 4. Speaker Connections

Depending on the type and number of speakers used with the amplifier, wire them to the speaker terminals as per the appropriate wiring diagram. For most applications, #18 gauge wire should be used for the speaker leads but in no case thinner than #20 gauge. For leads in excess of 10 feet, #16 gauge is recommended. When wiring the speakers, pay careful attention to the polarity of the terminals on the speakers and make certain they correspond to the polarity of the corresponding terminals on the amplifier. **DO NOT** ground any speaker leads to the chassis of the vehicle.

### 5. Input Connections

This amplifier features both high and low-level input capability. Use either the low-level or high-level inputs, not both.

If low-level outputs are provided from the car stereo, it is recommended that the low-level inputs be used for lowest distortion and best performance. Use good quality shielded audio cables with RCA plugs at both ends to connect the stereo to the amplifier and keep the cable lengths to a minimum to avoid noise.

If the car stereo does not provide low-level outputs, the amplifier may be connected via the speaker (high-level) outputs from the stereo. Wire the speaker leads from the car stereo to the 4-pin adaptor harness as shown in the diagram (shielded cable is not required for this application) and plug the connector into the mating High-Level Input connector on the amplifier. Carefully splice and insulate all wire connections.

**CAUTION:** Use either the low-level or the high-level inputs on the amplifier.  
**DO NOT** use both input levels at the same time.

# 4-CHANNEL AND MIXED-MONO INPUT WIRING DIAGRAM

USE THIS INPUT WIRING WITH OUTPUT WIRING ON PAGE 7 

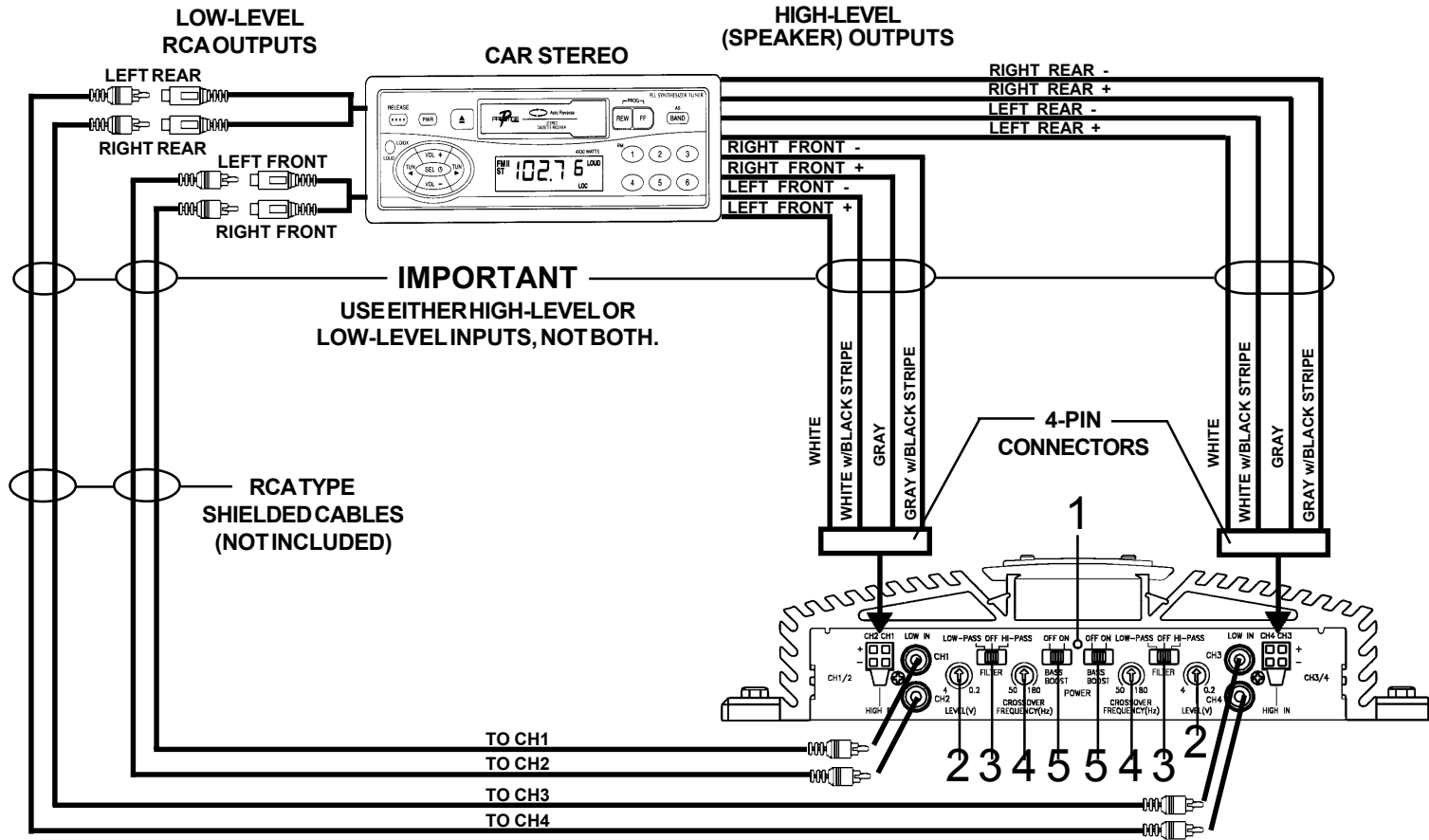



← USE THIS OUTPUT WIRING WITH  
INPUT WIRING ON PAGE 6

## 4-CHANNEL AND MIXED-MONO OUTPUT WIRING DIAGRAM

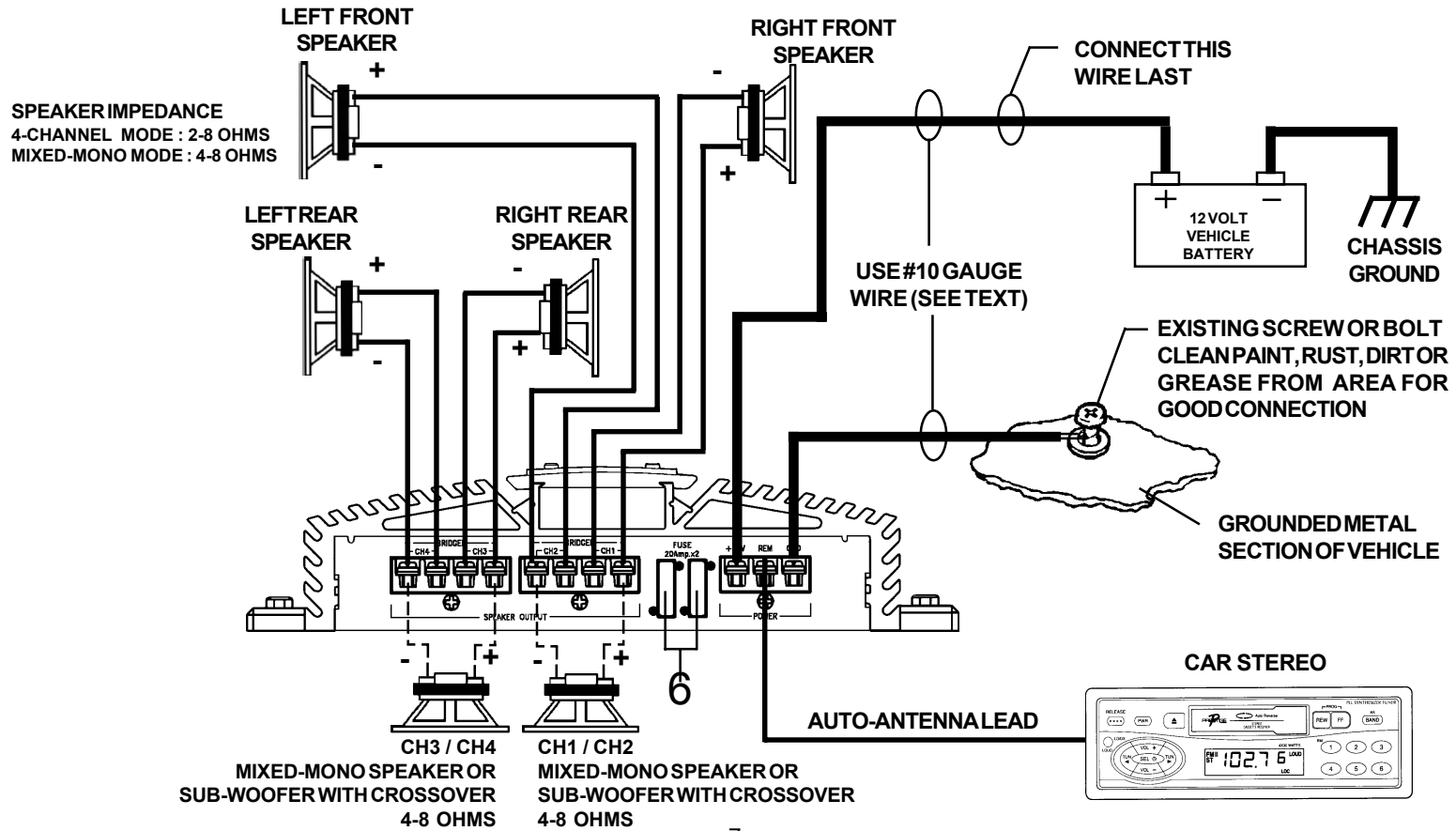

# 3-CHANNEL INPUT WIRING DIAGRAM

USE THIS INPUT WIRING WITH OUTPUT WIRING ON PAGE 9 

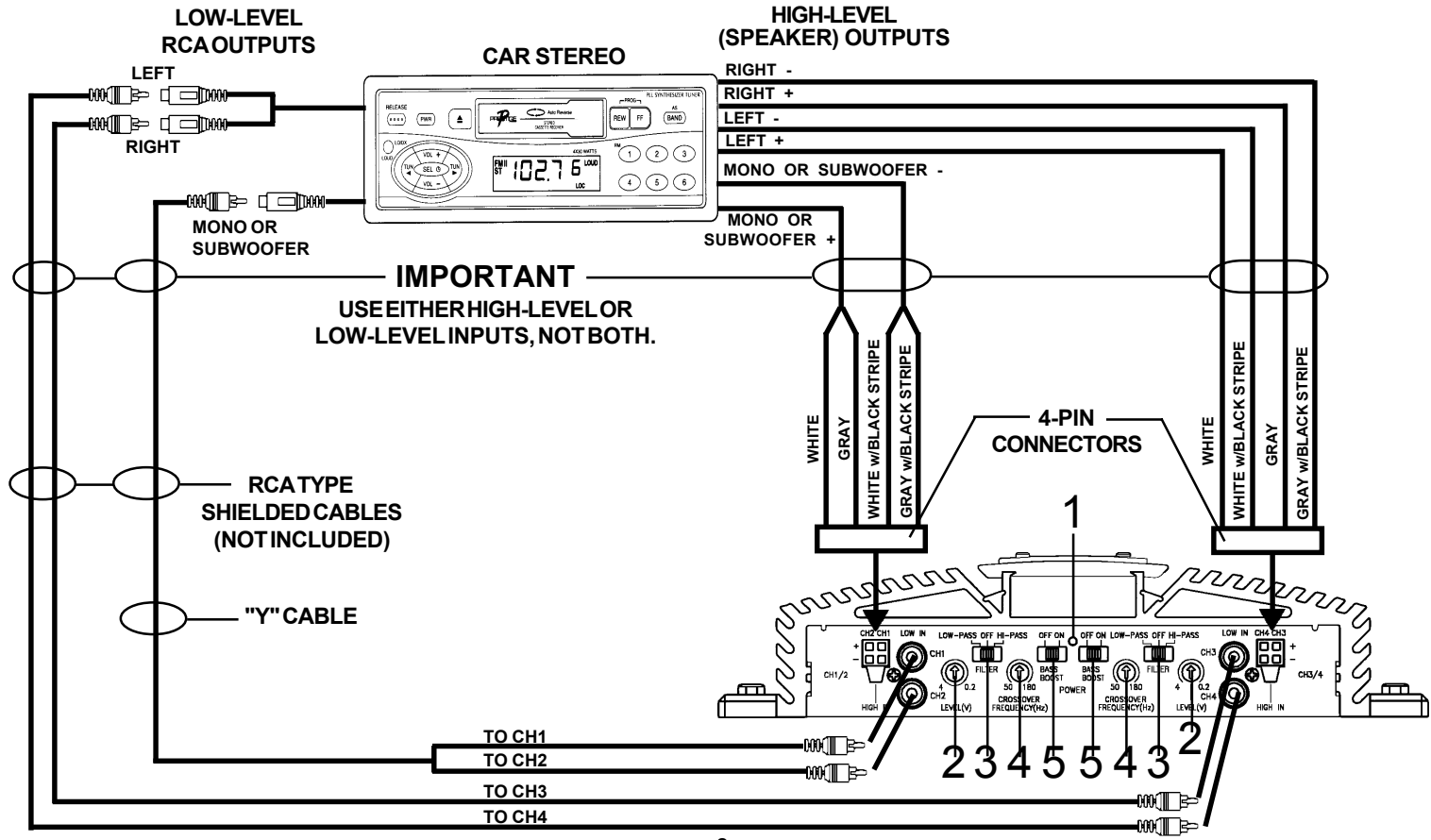

← USE THIS OUTPUT WIRING WITH  
INPUT WIRING ON PAGE 8

### 3-CHANNEL OUTPUT WIRING DIAGRAM

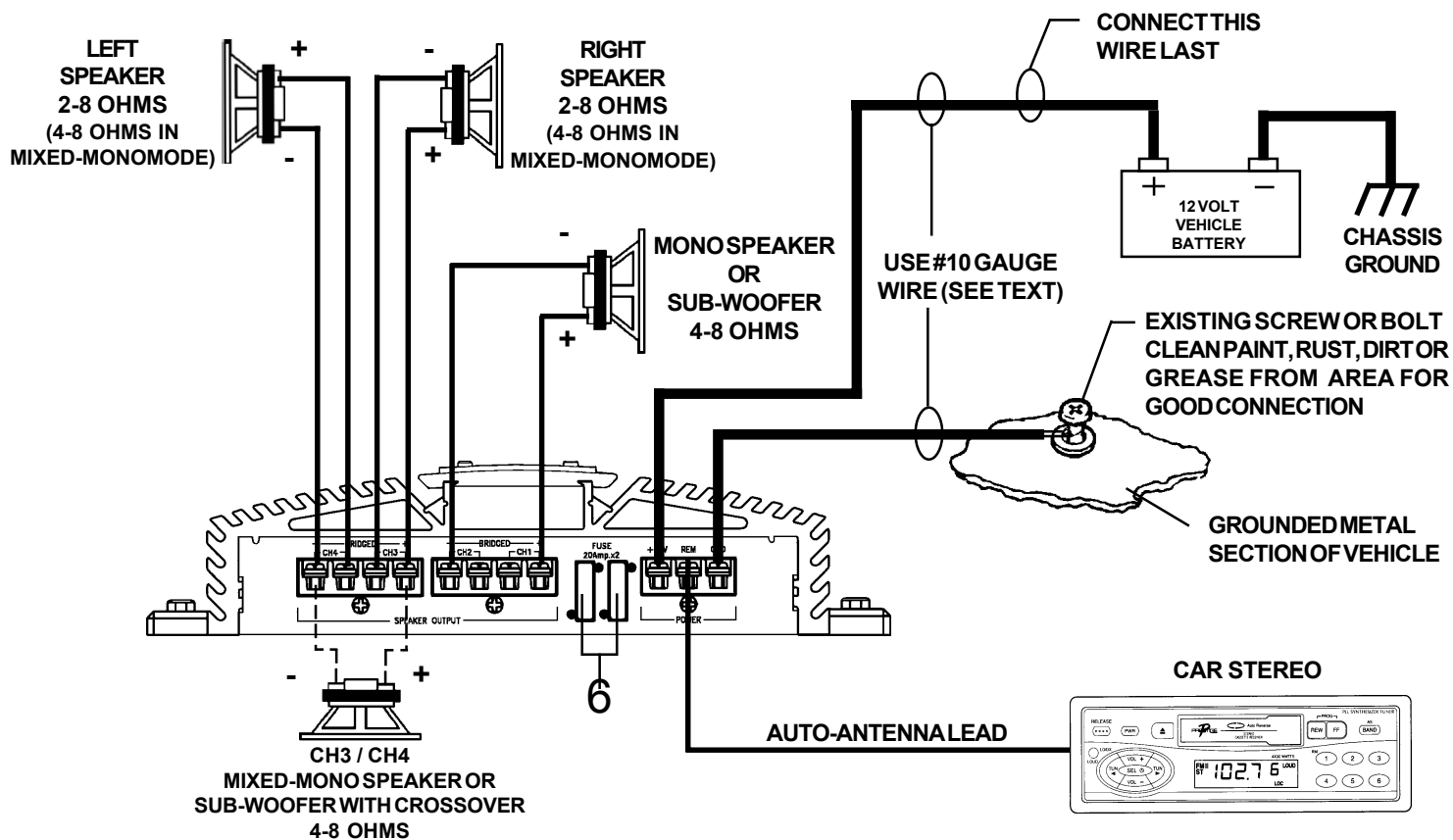

# 2-CHANNEL MONO (BRIDGED) INPUT WIRING DIAGRAM

USE THIS INPUT WIRING WITH  
OUTPUT WIRING ON PAGE 11 →

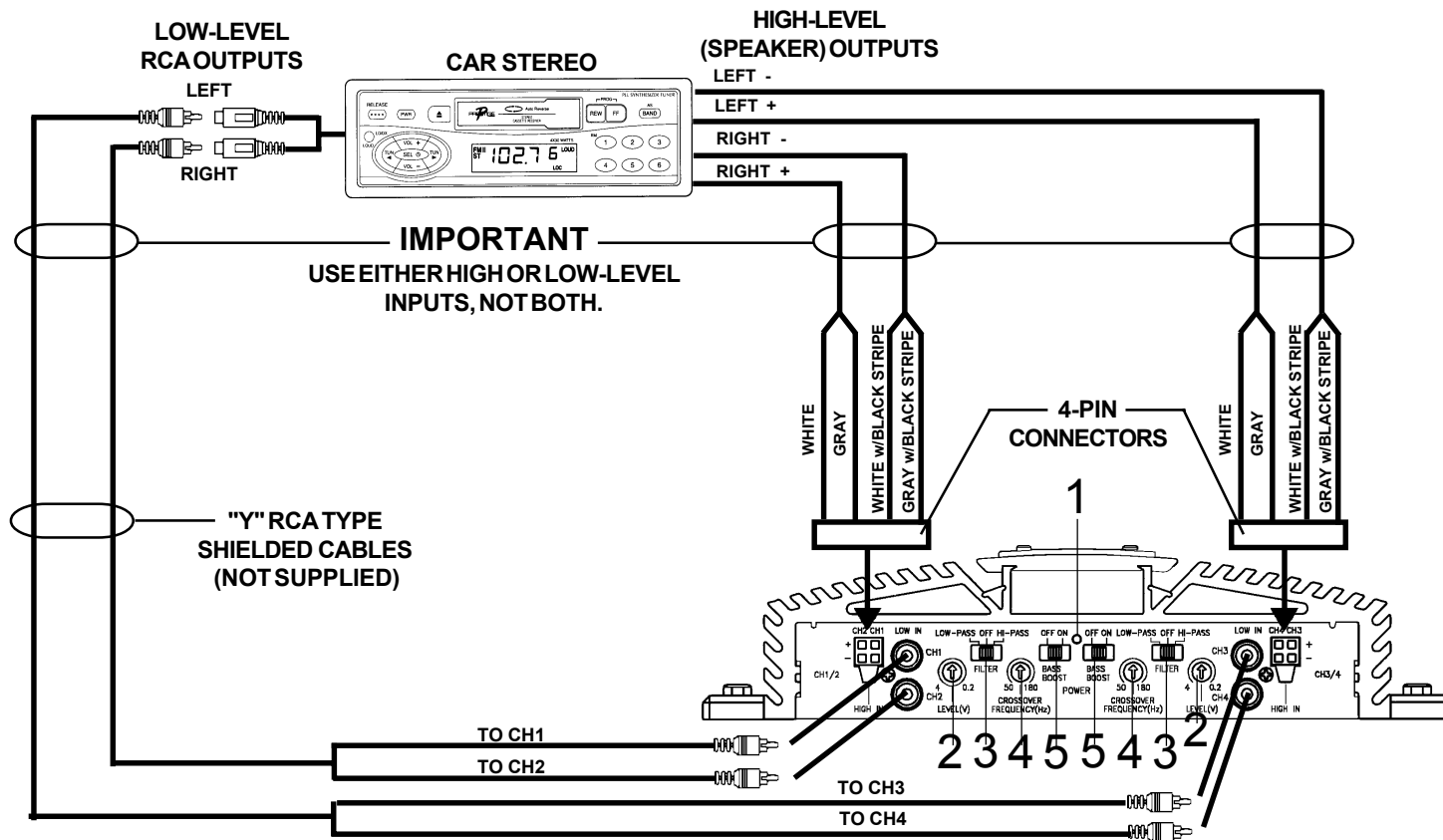

← USE THIS OUTPUT WIRING WITH  
INPUT WIRING ON PAGE 10

## 2-CHANNEL MONO (BRIDGED) OUTPUT WIRING DIAGRAM

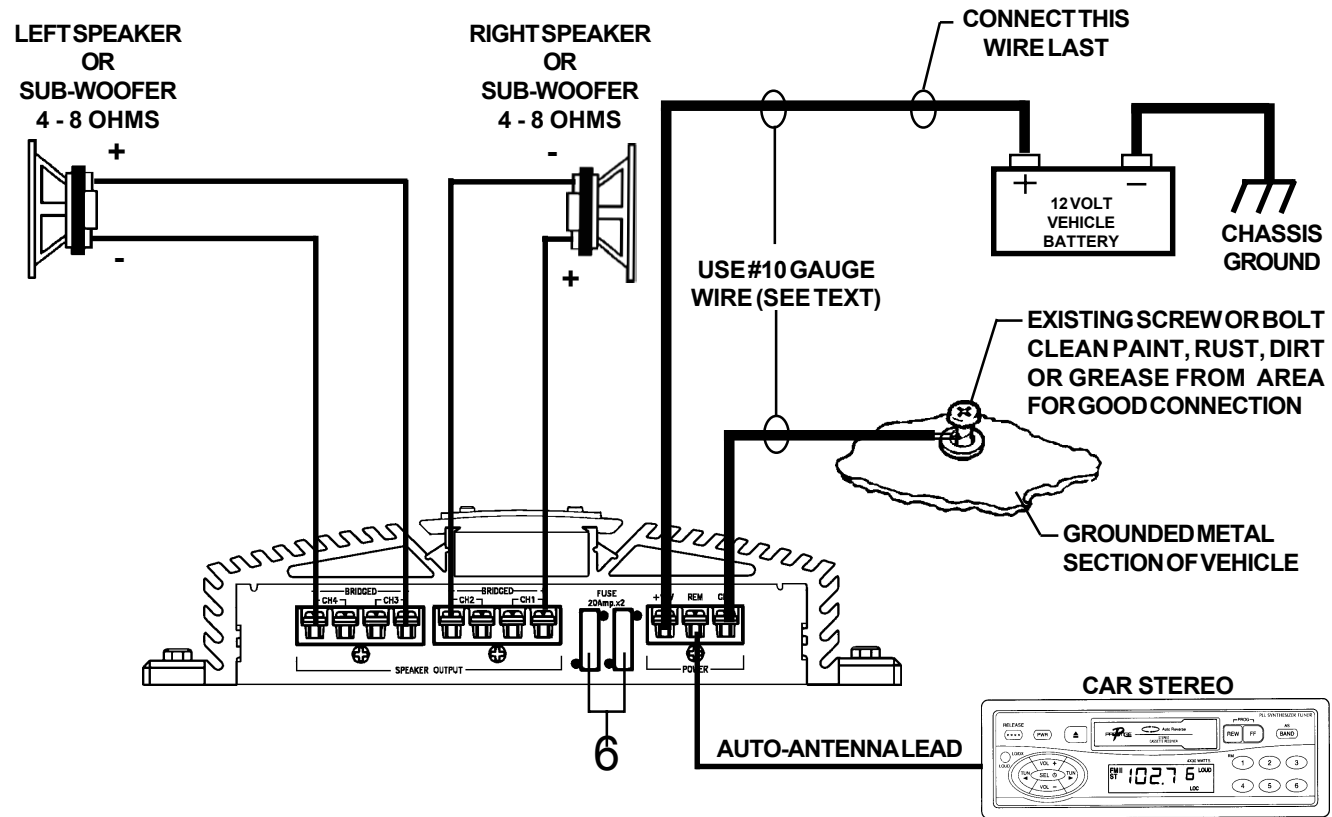

## OPERATION

After initial set-up, the amplifier should not require any further adjustment unless there is a change in the car stereo or speaker system with which it is used.

### **1** Power Indicator

The Power LED functions as a power and warning indicator. The indicator is white when the power to the amplifier is off. When the indicator is green, the amplifier is operating normally. The LED illuminates red to indicate that the self-protection circuits have been activated and have shut off operation of the amplifier. The protection circuits may be triggered by the temperature of the unit rising above a safe level or by an overload condition. If activated by a rise in temperature, the unit will resume operation after cooling off to a normal operating range. If activated by an overload condition, the source of the overload must be found and corrected to resume operation of the amplifier. Most overload conditions are caused by mis-wiring or operation into incorrect speaker loads. Re-check all wiring and connections if this situation occurs and correct as necessary.

### **2** Level (Gain) Controls

The amplifier is capable of operating from sources supplying a wide range of input levels. The Level controls should initially be set to the mid-rotation position. If it is found that there is not enough output even when the volume control on the car stereo is at its maximum setting, adjust the Level control of the respective channels to increase the output from the system. If, however, there is still output from the amplifier when the car stereo volume control is at its minimum setting, or the output level increases too fast with a small rotation of the volume control, adjust the Level control to decrease the output from the system. Once the correct setting is found, these controls should not require any further adjustment.

### **3 Filter Selectors**

These switches allow selection of the frequency filters that permit the respective channels of the amplifier to be used to reproduce the entire audio range, just the bass, or all frequencies above the bass range.

In the "OFF" position of the switch, the response is flat and unaffected so the entire audio frequency range is reproduced by the amplifier. Use this setting if the respective amplifier channels are being used to power a full range speaker system.

In the "LOW PASS" setting, only the bass frequencies below the frequency set by the Crossover Frequency Control will be amplified and fed to the speakers. Use this setting if the respective amplifier channels are being used to power a sub-woofer speaker system.

In the "HI-PASS" setting, only the frequencies above the frequency set by the Crossover Frequency Control will be amplified and fed to the speakers. Use this setting if the respective amplifier channels are being used to power the full-range speakers in a system that also has separate sub-woofer(s).

### **4 Crossover Frequency Controls**

These Controls select the crossover frequency when the Filter Selector is in the "LOW-PASS" or "HI-PASS" settings. Adjust them to the appropriate position for the characteristics and crossover frequency requirements of the speaker system with which the respective channels of the amplifier are being used.

### **5 Bass Boost Switches**

These switches are used to accentuate the bass frequencies by adding 8 dB of boost to the signal (at 45 Hz.) on the respective channels.

### **6 Fuses**

The circuitry of the amplifier is protected from damage by automotive-type fast-blow fuses. If fuse replacement is necessary, use only fuses of the same ampere rating as originally supplied with the unit. The use of fuses with incorrect ratings may cause serious damage to the amplifier. If fuses blow consistently, carefully check all electrical connections to the unit.



## 12 / 24 MONTH LIMITED WARRANTY

Applies to automotive radios, radio/tape players, radio/CD players, CD changers, power amplifiers, equalizers and accessories.

AUDIOVOX CORPORATION (the Company) warrants to the original retail purchaser of this product that should this product or any part thereof, under normal use and conditions, be proven defective in material or workmanship within 12 months from the date of original purchase, such defect(s) will be repaired or replaced with new or reconditioned product (at the Company's option) without charge for parts and repair labor.

To obtain repair or replacement within the terms of this Warranty, the product is to be delivered with proof of warranty coverage (e.g. dated bill of sale), specification of defect(s), transportation prepaid, to an approved warranty station or the Company at the address shown below. The warranty period will be extended to 24 months from the date of original purchase if the product is installed by an authorized Menace Audio dealer. To claim warranty service during this extended period, the bill of sale must specify that the product was installed by an authorized Menace Audio dealer.

This Warranty does not extend to the elimination of externally generated static or noise, to correction of antenna problems, to costs incurred for installation, removal or reinstallation of the product, or to damage to tapes, compact discs, speakers, accessories, or vehicle electrical systems.

This Warranty does not apply to any product or part thereof which, in the opinion of the Company, has suffered or been damaged through alteration, improper installation, mishandling, misuse, neglect, accident, or by removal or defacement of the factory serial number/bar code label(s). THE EXTENT OF THE COMPANY'S LIABILITY UNDER THIS WARRANTY IS LIMITED TO THE REPAIR OR REPLACEMENT PROVIDED ABOVE AND, IN NO EVENT, SHALL THE COMPANY'S LIABILITY EXCEED THE PURCHASE PRICE PAID BY PURCHASER FOR THE PRODUCT.

This Warranty is in lieu of all other express warranties or liabilities. ANY IMPLIED WARRANTIES, INCLUDING ANY IMPLIED WARRANTY OF MERCHANTABILITY, SHALL BE LIMITED TO THE DURATION OF THIS WRITTEN WARRANTY. ANY ACTION FOR BREACH OF ANY WARRANTY HEREUNDER INCLUDING ANY IMPLIED WARRANTY OF MERCHANTABILITY MUST BE BROUGHT WITHIN A PERIOD OF 30 MONTHS FROM DATE OF ORIGINAL PURCHASE. IN NO CASE SHALL THE COMPANY BE LIABLE FOR ANY CONSEQUENTIAL OR INCIDENTAL DAMAGES FOR BREACH OF THIS OR ANY OTHER WARRANTY, EXPRESS OR IMPLIED, WHATSOEVER. No person or representative is authorized to assume for the Company any liability other than expressed herein in connection with the sale of this product.

Some states do not allow limitations on how long an implied warranty lasts or the exclusion or limitation of incidental or consequential damage so the above limitations or exclusions may not apply to you. This Warranty gives you specific legal rights and you may also have other rights which vary from state to state.

**U.S.A. :** AUDIOVOX CORPORATION, 150 MARCUS BLVD., HAUPPAUGE, NEW YORK 11788 1-800-645-4994

**CANADA :** CALL 1-800-645-4994 FOR LOCATION OF WARRANTY STATION SERVING YOUR AREA

128-5574